

## **ARRL Dualband Momobeam 6/10**

Dualband Beam Antenna

10 Meter Moxon (28 MHz)

and

6 Meter Yagi (50 MHz)

**Produced exclusively for**

**ARRL The National Association for Amateur Radio®**

by Momobeam

ARRL Item No. 0084



# DUO4 6-10 MOXON

Dualband Yagi Antenna  
28 – 50 MHz

## ASSEMBLY MANUAL

### Momobeam

C.da Barbarello 508 - IT-91025 Marsala Italy  
P.Iva IT-02439250818 Tel. +39 393 9906980  
[www.momobeam.com](http://www.momobeam.com) – [info@momobeam.com](mailto:info@momobeam.com)

The content of this manual is the intellectual property of Momobeam. No part of this publication may be reproduced or transmitted in any form or by any means without prior permission of Momobeam.

Please, carefully read this assembly manual before starting to assemble the antenna.

### Limited Warranty and Liability

Momobeam warrants to the original purchaser that this product will be free from defects in material and workmanship for a period of two (2) years from the date of purchase. Momobeam will solely determine whether a part will be covered by this limited warranty and whether a part will be repaired or replaced. Such determination will be made following the evaluation of alleged defect. Momobeam will evaluate if misuse, abuse, unauthorized modifications, extreme weather conditions or improper installation occurred. This warranty does not cover delivery, transportation, installation or any other cost that may be incurred from any defect. Shipping costs for any repairs, replacements or returns will be paid by the buyer and must be prepaid. Before proceeding with the evaluation, Momobeam will have to receive appropriate documentation that helps identify any defect. The purchaser, final customer, installer and user of Momobeam products acknowledge that these products can cause injury or death and accept full responsibility and liability for any and all damage to persons and to property (direct, indirect and punitive) caused during installation and subsequent use.

### Warning

Do not install this antenna where there is any possibility that the antenna or any part of the supporting structure could come in contact with power lines or any electric circuit. If the antenna comes in contact with electric circuits, this could result in electric shock or loss of life. Also ensure that no people or pets can come in any contact with the antenna after it is installed. Dangerous voltages can exist on the antenna when it is in operation and no part of the system is insulated to prevent electric shock. Momobeam antennas are not designed to be used as support structures. Persons or objects should never be supported by or suspended from the antenna structure. It must be taken into account that falling parts may cause a hazard to people, animals and property on the ground below.

**Disputes** For any dispute, only the Marsala - Italy headquarters is your point of contact and has the final authority.

**Contact** If you have any questions regarding the assembly or operation of this antenna, please contact Momobeam:

### (ARRL) Momobeam di Giuseppe Spanò

C.da Berbarello 508 - IT - 91025 Marsala Italy

P.IVA IT-02439250818 [www.momobeam.com](http://www.momobeam.com) – [info@momobeam.com](mailto:info@momobeam.com)

### Momobeam USA

[usa@momobeam.com](mailto:usa@momobeam.com)

Tel. 603-973-5963 (Eastern Time Zone)

[www.momobeam.com](http://www.momobeam.com) – [info@momobeam.com](mailto:info@momobeam.com)

## ASSEMBLY ADVICE

The Momobeam Yagi **DUO4 6-10M** antenna is a lightweight, yet robust product and is well suited for portable use.

All parts are labelled to make assembly quick and easy.

All elements are pre-drilled at the factory and no measuring or calibration is required.

**It is made of aluminium tubes, galvanized steel hardware, UV-resistant POM-C driver insulators and polypropylene clamps.**

**It is strongly recommended that you lubricate stainless steel hardware before tightening it to prevent seizure. Penatrox is the recommended lubricant.**

**Please, do not over-tight. Extreme force is not required! Once hardware begins to seat firmly, only need a few more turns to properly secure parts.**

**NOTE: Reference to Standard American English (SAE) or Imperial units are approximate where noted.**

## Momobeam

C.da Berbarello 508 - IT-91025 Marsala Italy

P.Iva IT-02439250818 Tel. +39 393 9906980

[www.momobeam.com](http://www.momobeam.com) – [info@momobeam.com](mailto:info@momobeam.com)

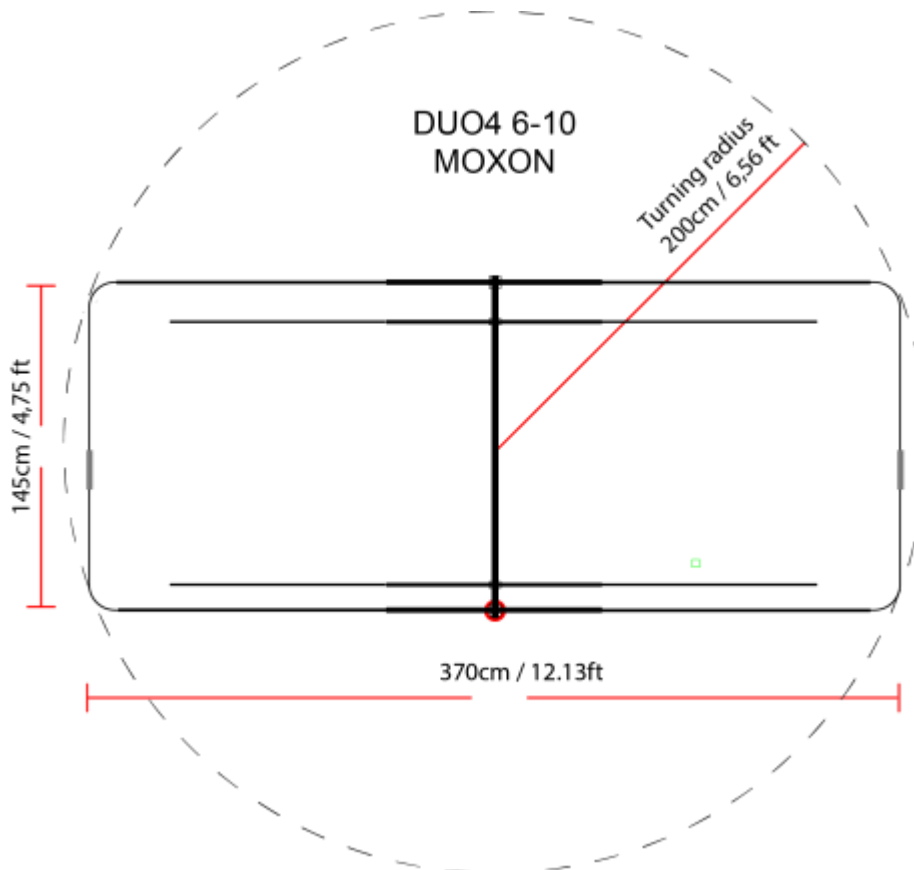

### Design Concept – Two Unique Design Features in One Antenna

One of the unique qualities of this antenna is the feed system for the 50 MHz portion of this dual band antenna. It utilizes the Open Sleeve Feed Method, where there is no physical connection to the Driven Element of the 50 Mhz section and the coupling is based on element proximity and length that allows 50 Mhz energy to couple from the 10 M Driven Element with minimal loss. This technology was developed by N6BT and Sommer DJ2UT. Refer to the ARRL Antenna Book for more detail on this design.

This feed method for 50 MHz provides a simple, lightweight and efficient design for the user.

Note that the Driven Element for 50 MHz is labelled O-S for Open Sleeve.

The second unique design feature: The antenna is a Moxon for the 10 M band, developed originally by G6XN. This design very effectively reduces the traditional yagi to a size typically 30% smaller. and utilizes not traps or other shortening techniques that reduce performance bandwidth. The Moxon has the reputation of being a high performance antenna with no trade offs. It is ideal for the wide bandwidth of 10 M.

## Inventory Check List

Item	Qty	Description	Placement
ALU. TUBE.35.2.150	1	Aluminum round tube Ø 35mm 2mm thick - length 150cm	Boom
ALU. TUBE.16.100.C	1	Round tube Ø 20mm - length 100cm - 1,5mm thick	Element A
ALU. TUBE.16.100.C	2	Round tube Ø 16mm - length 100cm - 1,5mm thick	Element B/C
ALU. TUBE.16.103.DR	1	Round tube Ø 20mm - length 103cm - 1,5mm thick (preassembled driver element with POM-C UV-Resistant insulator)	Element D
ALU. TUBE.16.150.I	4	Round tube Ø 16mm - length 150cm - 1,5mm thick	Element A/D
ALU. TUBE.12.88TM	2	Round tube Ø 12mm - length 88cm - 1mm thick (MOXON)	Terminal element A
ALU. TUBE.12.112T	2	Round tube Ø 12mm - length 112cm - 1mm thick	Terminal element B
ALU. TUBE.12.104T	2	Round tube Ø 12mm - length 104cm - 1mm thick	Terminal element C
ALU. TUBE.12.66TM	2	Round tube Ø 12mm - length 66cm - 1mm thick (MOXON)	Terminal element D
<b>BOOM TO MAST PLATE</b>			
Boom to mast plate	1	Qty 1 Aluminum plate 150x80x5mm Qty 2 galvanized U-Bolt M8 d.35 with washers and wing nuts Qty 2 galvanized U-Bolt M8 d.50 with washers and wing nuts	
<b>HARDWARE BAG</b>			
Moxon spacer bag	1	<b>Insulating Moxon spacers:</b> Qty 2 D16x260mm PVC tube	Element A/D end section
clamp & hardware bag 28 MHz	2	<b>clamp &amp; hardware bag 28 MHz:</b> Qty 1 Polypropilene clamp Ø35mm (d.20) Qty 2 M6 80mm galvanized screws with wings Qty 2 M6 galvanized wing nuts Qty 2 M6 galvanized washers Qty 6 M4 30mm galvanized screws with wings Qty 6 M4 galvanized wing nuts Qty 6 M4 galvanized washers	Element A/D
clamp & hardware bag 50 MHz	2	<b>clamp &amp; hardware bag 28 MHz:</b> Qty 1 Polypropilene clamp Ø35mm (d.16) Qty 2 M6 80mm galvanized screws with wings Qty 2 M6 galvanized wing nuts Qty 2 M6 galvanized washers Qty 2 M4 30mm galvanized screws with wings Qty 2 M4 galvanized wing nuts Qty 2 M4 galvanized washers	Element B/C
Pigtail SO 239		<b>PIGTAIL SO239 connector</b>	Element D Feedpoint
Mounting tool bag		<b>Mounting tools</b>	
Bolts for fixed station assembly bag	1	Qty 8 M6 80 stainless steel bolt Qty 16 M6 stainless steel washer Qty 8 M6 stainless steel Self-locking nut  Qty 16 M4 30 stainless steel bolt Qty 16 M4 stainless steel washer Qty 16 M4 stainless steel Self-locking nut  Qty 8 M8 galvanized Self-locking nut	
Manual	1	<b>EN Assembly manual</b>	

### STEP 1 - BOOM ASSEMBLY

The boom of the **DUO4 6-10M** is supplied in one piece, no assembly is required. Note the element layout A through D and boom center.

### STEP 2 - BOOM-TO-MAST PLATE ASSEMBLY

Boom-to-mast plate is made of one aluminum plate with 8 holes. External holes (on smaller width sides) are for 2X small U-Bolt clamps. Assemble clamps so that they "hug" the boom. Position the plate like shown in the picture below. The center of the plate must correspond to the center of the label on the boom central part (75 cm/29.5 inches from boom start). Firmly tighten bolts. Boom-to-mast plate must be mounted perpendicular to the ground. Pictured below are the U Bolts using the Portable style nuts (Wing Nuts) for rapid deployment. For a permanent installation, use the standard nuts found in the bag.

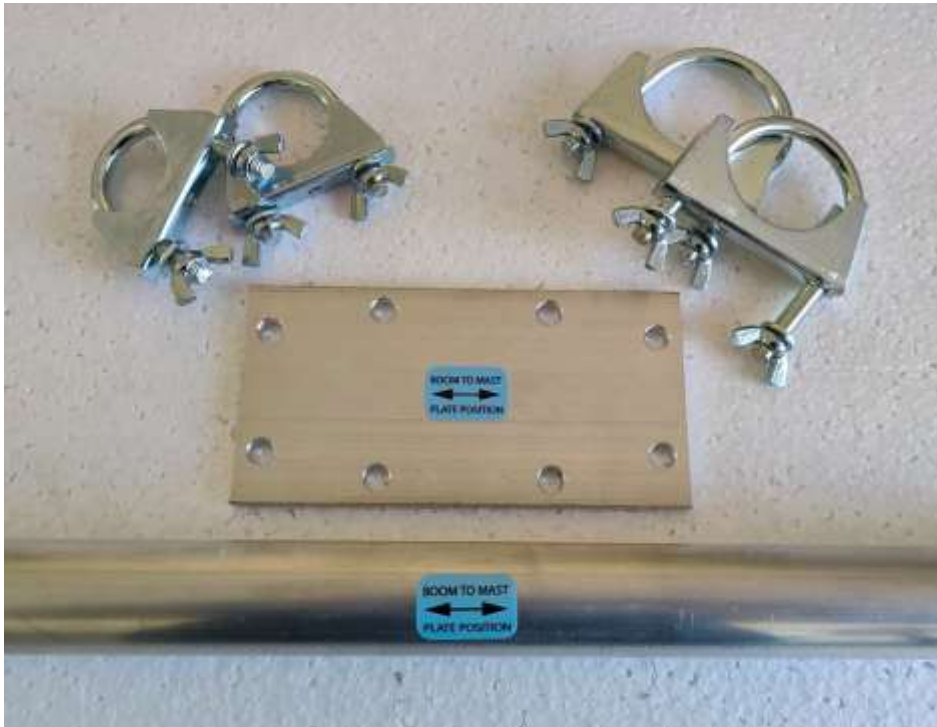

### STEP 3 - ELEMENT ASSEMBLY

The elements of the **DUO4 6-10M** for 50 MHz (elements B and C) consist of two sizes of aluminium tubes:  
diameter 16 mm for the intermediate sections  
diameter 12 mm for the end sections.

The elements of the DUO4 6-10M for 28 MHz (elements A and D) consist of three sizes of aluminium tubes:  
diameter 20 mm for the central section  
diameter 16 mm for the intermediate sections  
12 mm diameter for the end sections. These end sections have the special feature of being curved and are used to make the Moxon rectangle.  
Each element is labelled.

The central section has two holes in the center for boom attachment and two holes at the ends.  
Use these two center holes to attach the element to the boom using the clamp and two bolts. The elements are mounted below the boom with screw heads on top, locking nuts on bottom. Pictured below are the element mounts using the Portable style nuts (Wing Nuts) for rapid deployment. For a permanent installation, use the standard nuts found in the bag.



Clamp bag

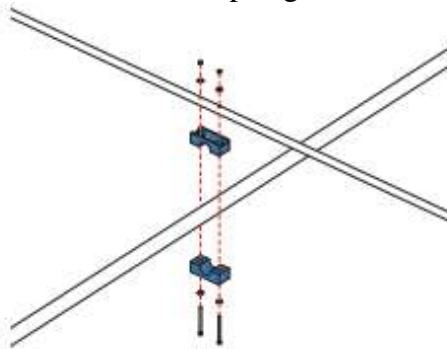

Locate the intermediate and terminal parts for each element by checking the labels.

Now proceed with the assembly of the intermediate elements with elements: A and D and the terminal elements elements: B and C).

## DUO4 6-10 MOXON

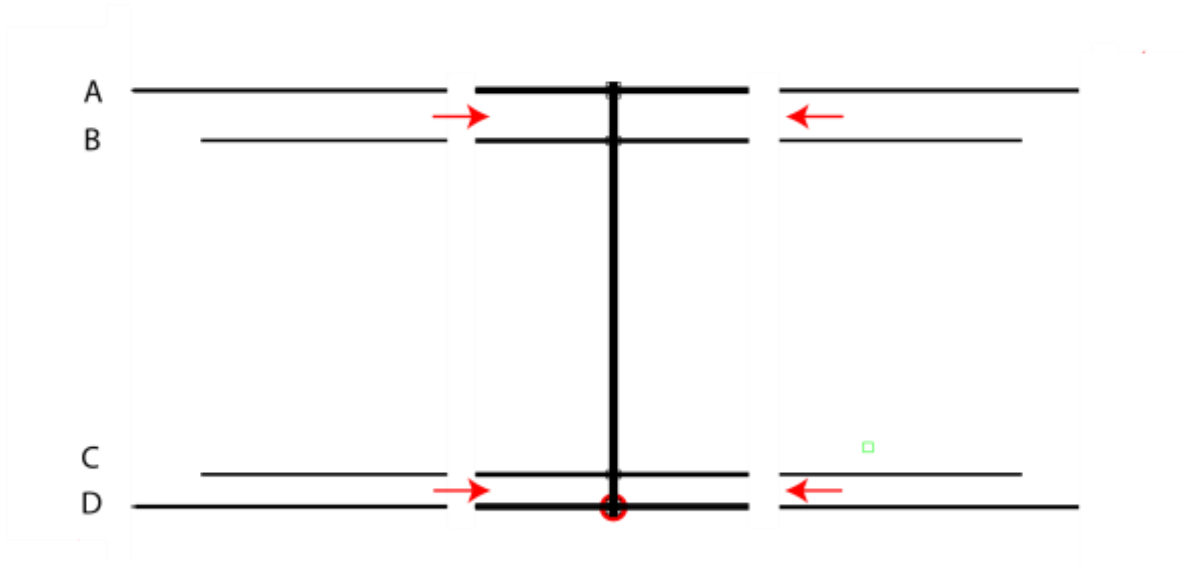

**Please Note: The curved end pieces that form the Moxon element for 28 MHz (labels A and D) are mounted last.**

Slide the element terminal part into the corresponding central part until holes align. Please note that the central element part has two size holes. Secure the elements sections with one bolt, one washer and one washer one self locking nut. **The head of the bolt must be inserted into the larger diameter hole**, thru the smaller diameter tube and it must exit thru the small hole in the bigger diameter tube on the opposite side. This creates a strong mechanical and electrical joint. The element is placed below the boom, with the head of the locknuts up and the screw head down.



## DUO4 6-10 MOXON

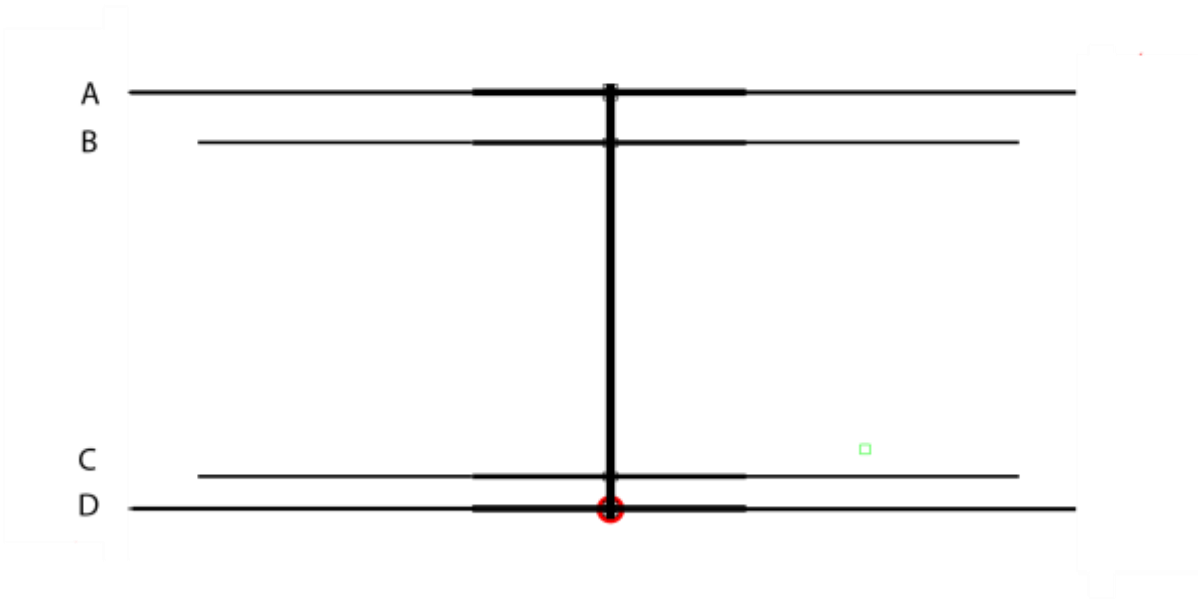

### Final Assembly Step:

All that remains is to assemble the curved elements that make up the Moxon rectangle, including the insulating tube that will join the two curved elements (the insulating tube has hardware already attached). The attachment screws are the same distance to the end of the insulator, so either end can be used.

## DUO4 6-10 MOXON

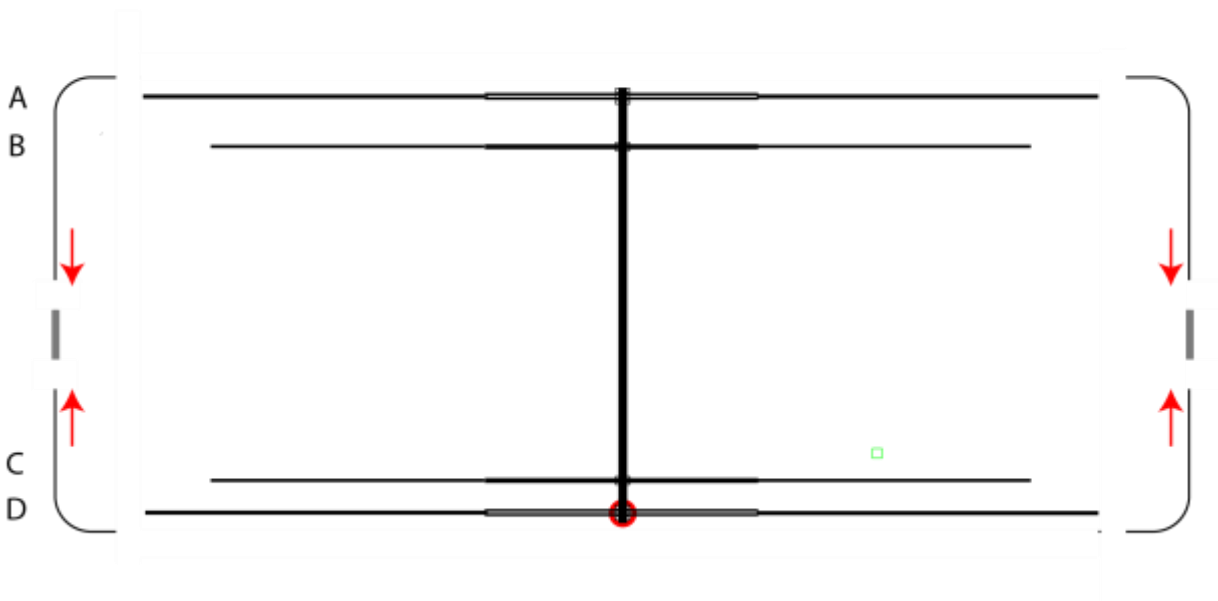

Insert curved terminal element A into the insulator tube and secure it with a flat washer, bolt and self-locking nut. Now insert the curved element D into the other end of the insulator tube and secure it with a flat washer, bolt and self-locking nut.

Repeat this sequence with the remaining two curved pipes and insulator tube.

### DUO4 6-10 MOXON

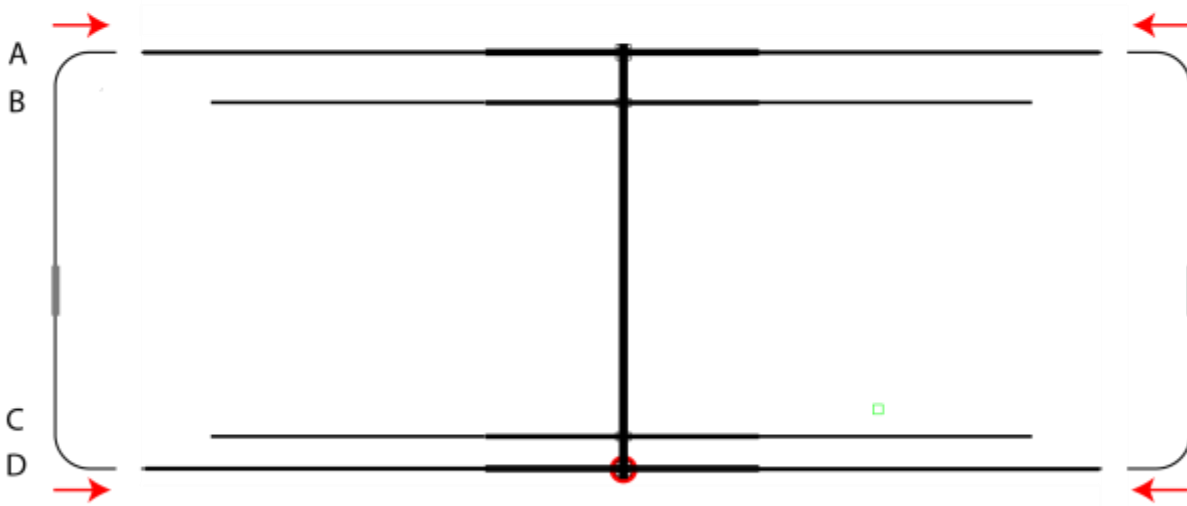

Now insert the two ends of the U-shaped tube into tubes A and D and secure at both ends with a washer bolt and self-locking nut.

Repeat this sequence on the opposite side of the antenna.

### DUO4 6-10 MOXON

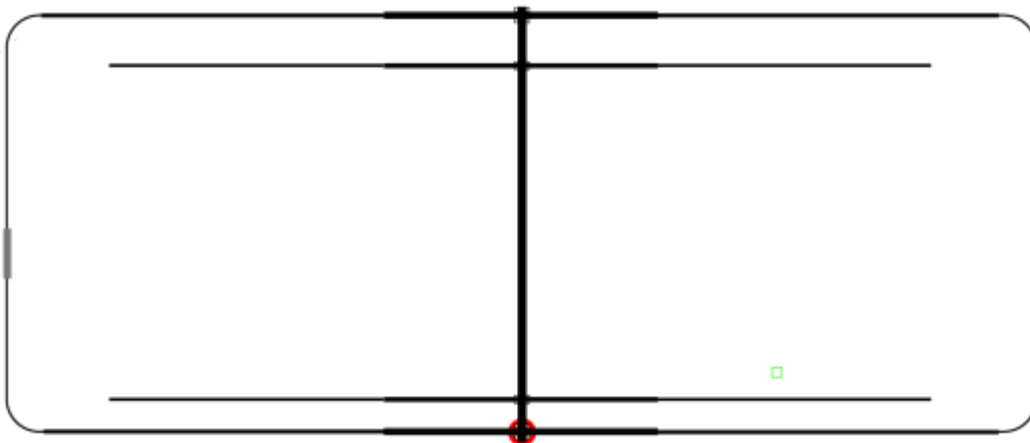

Now the antenna is completely assembled and all that remains is to connect the coax pigtail using the pigtail lugs to either terminal on element D. The main coaxial transmission line is connected to the UHF Female connector on the pigtail and secured to the boom and mast with customer supplied tape or tie wraps. It makes no difference how the pigtail is configured at the terminals (there is no polarity issue).

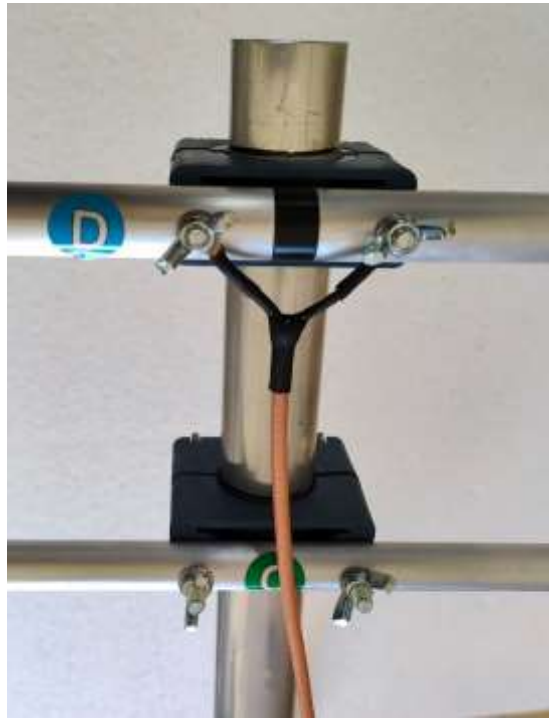

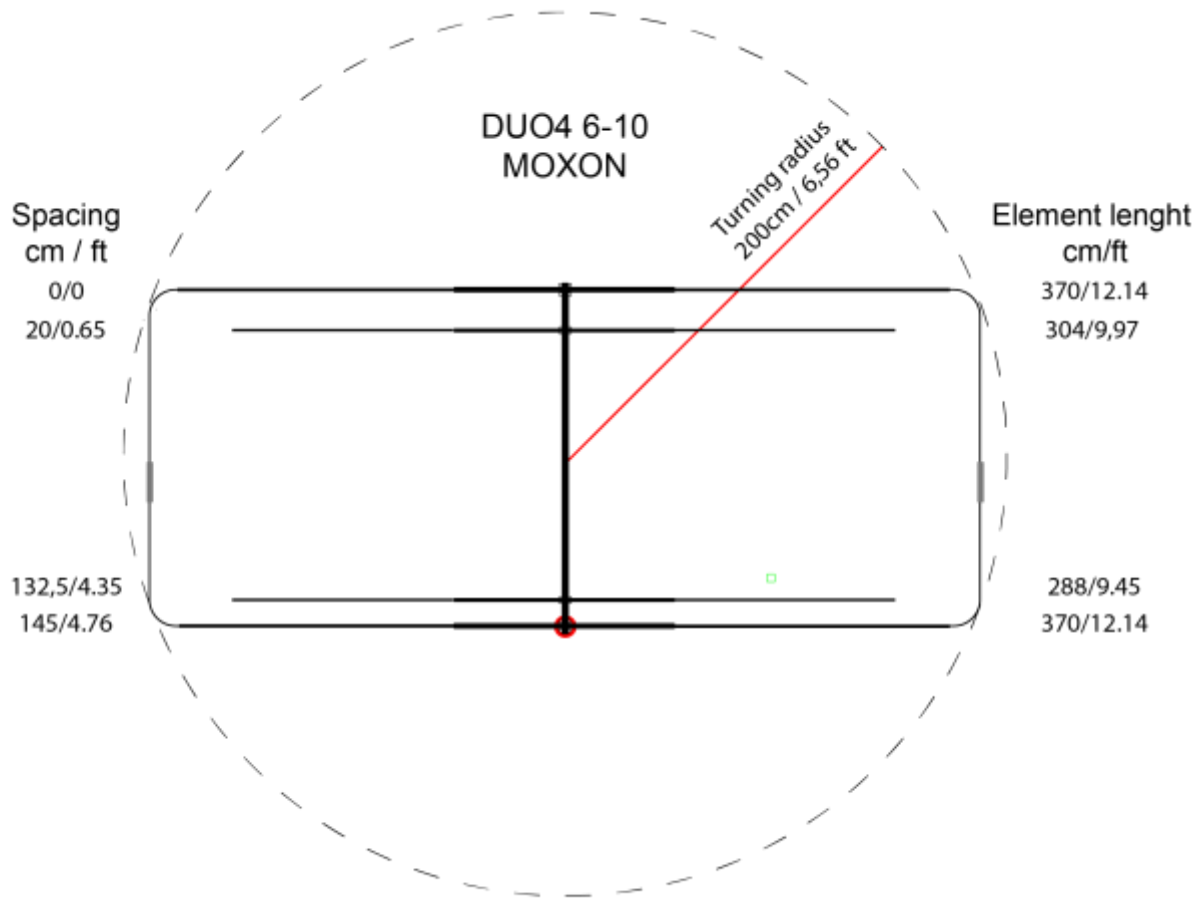

### Installation Suggestions

1. If the final location of the antenna is mast mounted, with no other antennas nearby, the antenna can be lifted over the top of a short mast, then secured to the mast.
2. If the final location of the antenna is near other mast mounted antennas and it is not possible to mount as described in item 1, it is suggested one insulator tube (connecting the 28 MHz elements in the Moxon), be removed so the antenna has a clear path to the mast for mounting. The side that has the removed insulating tube should be the side where the Boom-to-Mast U Bolts are located. Once the boom-to-mast plate is near its final location, position the antenna so the insulator tube can be re-installed to complete the Moxon rectangle. Then mount the antenna to the mast.
3. Dress feed line appropriately down the mast and secure with electrical tape or UV rated tie wraps. Be sure to provide a service loop around the rotor area for smooth operation.

## TROUBLESHOOTING

### **SWR significantly higher than specified values?**

- Check the connections of the coaxial cable between transmitter and antenna (connector soldering and cable continuity and SWR with a proper 50 ohm load).
- Check the operation of the RF Choke – same as coaxial cable test above.
- Check all measurements and spacing.

### **Interaction with nearby metal objects or other antennas**

If no errors are found in the measurements, it is likely that your antenna has been mounted at an insufficient height (less than 10 meters) or it is possible that there is an interaction with other antennas or metallic objects (if they are less than 3 meters / 10 ft away).

If it is not possible to increase the distance between the antennas, try to rotate the interfering antenna 90°.

### **Hardware**

On occasion, hardware may become seized when you tighten or loosen some stainless steel parts. The seizure is mainly due to the chemical nature of the material that undergoes a sudden heating of surfaces due to friction during assembly. If this happens, a nut can become seized. If this happens, it is necessary to force the tightening until the bolt breaks and then proceed with its replacement.

**It is strongly recommended that you lubricate stainless steel bolts before tightening it to prevent seizure.**

### Typical SWR Curves

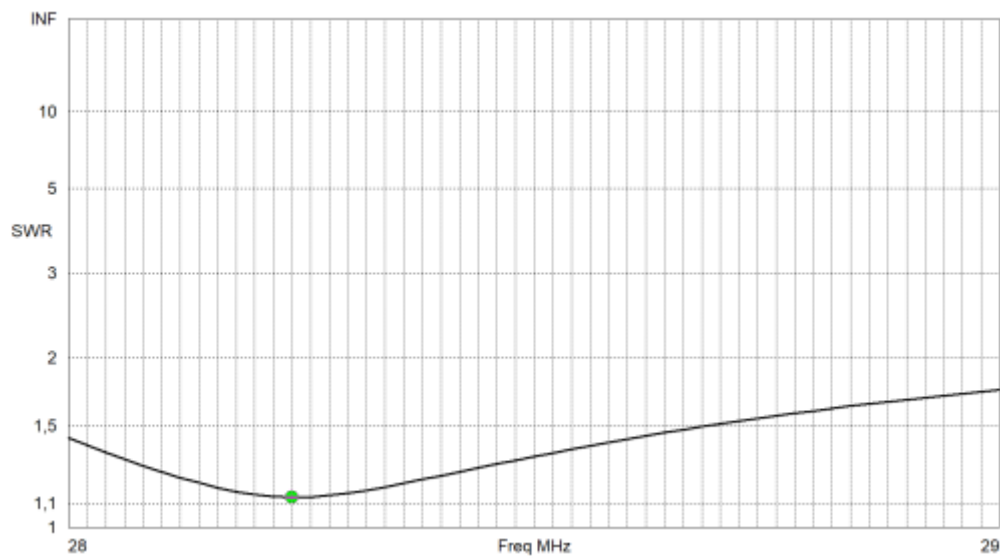
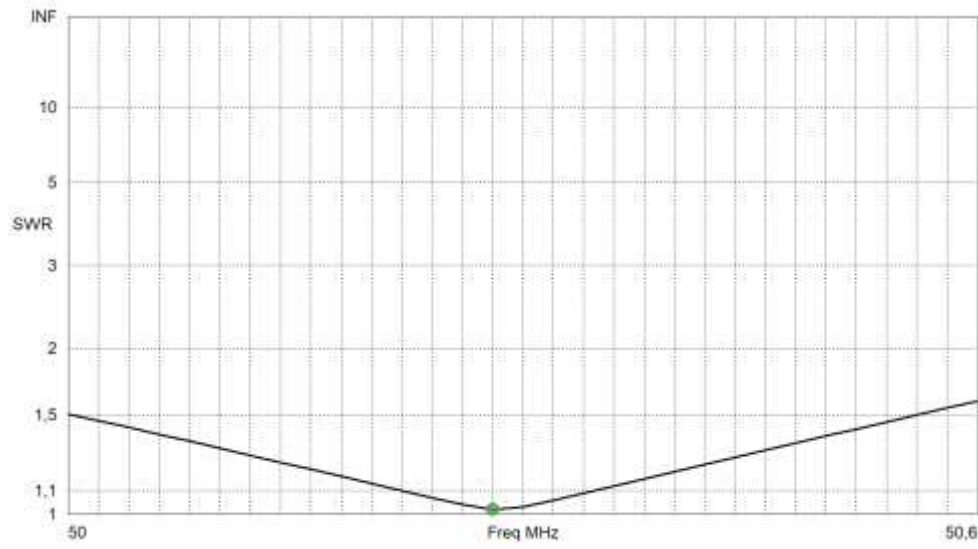

<b>BAND</b>	<b>10 meters - 28 MHz</b>	<b>6 meters - 50 MHz</b>
<b>Gain (dBi)*</b>	11.46	11.6
<b>Gain free space (99dBI)</b>	6.23 (4.09 dBd)	5.97 (3.83 dBd)
<b>Front/back ratio (dB)</b>	20	10
<b>Elements</b>	2 (Moxon)	2 (Yagi-Uda)
<b>SWR &lt;1.5:1</b>	28 to 28.8 MHz	50 to 50.6 MHz
<b>Longest element:</b>	370cm / 12.14 ft.	
<b>Boom length:</b>	150cm / 4.92 ft	
<b>Turning radius:</b>	200cm / 6.56 ft	
<b>Feed:</b>	50 Ohm balanced – single coaxial cable	
<b>Mast diameter:</b>	50mm / 2 inches (larger on request)	
<b>Wind area:</b>	0.2 m <sup>2</sup> /2.15 sq ft	
<b>Wind survival**:</b>	100 Km/h – 60 MPH	
<b>Connector:</b>	SO-239 Female attached to Coaxial Pigtail	
<b>Weight (excluding packaging):</b>	4.8 kg / 10.8 lbs.	
* gain at 20 m height on real ground		
** maximum wind speed at which there is no permanent deformation of the antenna		