

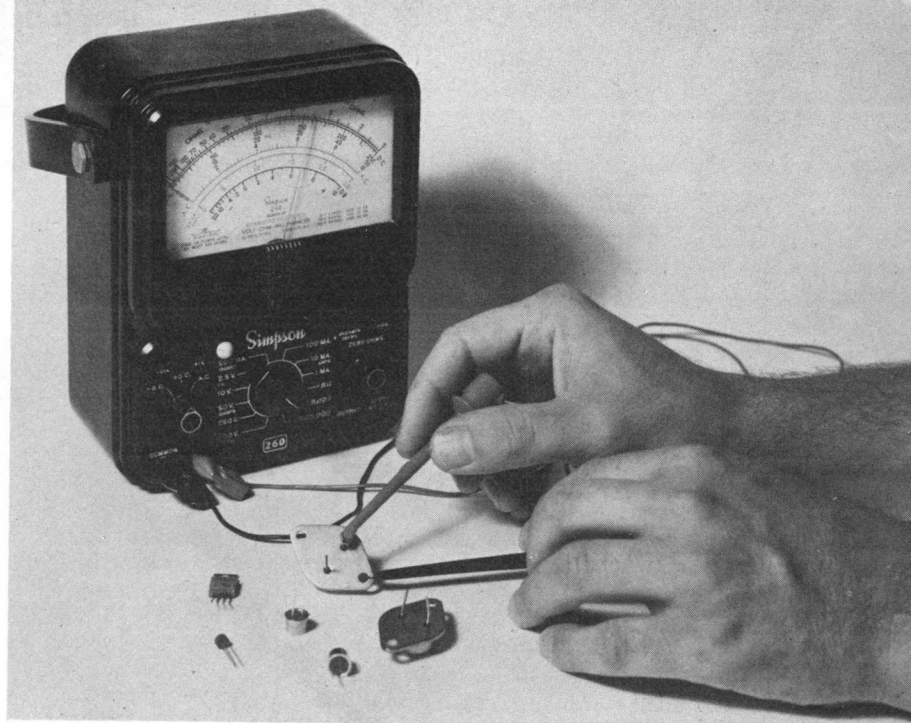

Some Basics for Equipment Servicing



Part 1: Costly repairs to amateur equipment can often be avoided if we do our own repair work. Knowing the nature of semiconductors is a vital means to that end.

By Doug DeMaw,* W1FB

“Gosh, I sure wish the ARRL would have a series of articles on how to fix ham gear at home!” Have we heard or read that comment at Hq.? You bet we have! Our dereliction has not been intentional. Rather, we wondered how such a series might be structured to provide an effective set of practical guidelines. With all of the brands and models of commercial gear in use today, where would we start? The answer seemed to be elusive until we reasoned that a *general treatment* of the basic troubleshooting procedures for solid-state circuits should be entirely applicable to most amateur equipment.

Servicing Commercial Gear

It can be perplexing to peer into the cabinet of today's factory-built equipment. Our eyes are greeted by countless circuit-board modules, most of which stand on end in inaccessible areas of the gear. It's logical to ponder, “How in the world can I check these circuits, and where shall I start?” Rule number 1 should be to purchase the factory service manual for the equipment we own. Rule number 2 calls for buying circuit-board

extender cards or cables from the manufacturer. If they aren't available, things will get pretty “sticky” when servicing is necessary. The factory manual provides detailed data on the individual modules in our rigs, X-ray views (sometimes) of the pc boards, lists of typical failures and the causes, and alignment procedures. Extender cables, on the other hand, permit us to extract the suspected module and test it with signal and operating voltage applied. This is important when attempting to locate a faulty voltage or component.

The standard operating manual that comes with most amateur equipment is fairly deficient with respect to servicing information, but the circuit diagrams may be adequate for much of the troubleshooting work. It is practical in some instances to make our own extender cables, provided we can obtain mating sockets for the plug-in pc-board modules. This approach should not be overlooked as an economy measure.

Basic Test Equipment

We need not own a research lab in order to repair our own gear (although at times it might help!). Most of the common

failures can be resolved through the use of a high-impedance VOM (VTVM or FET VM).¹ An oscilloscope is a very useful tool, but it will be of little use in signal tracing and analysis unless it responds well to the frequency of the circuit under investigation. We are concerned in this case with the *bandwidth* of the scope. If the instrument has, say, a 30-MHz bandwidth, it should be accurate up to that frequency, and it should be able to yield an accurate waveform display up to 30 MHz. But, if harmonic or spurious energy is present very far above 30 MHz, it won't appear on the waveform being investigated. Ideally, we would have a scope with a 250- or 500-MHz bandwidth for our amateur repair work. Some of the older Tektronix and Hewlett-Packard vacuum-tube scopes can be purchased used at reasonable prices. Check the big radio flea markets for bargains in used test equipment.

A signal generator is recommended if signal tracing and alignment work is to be done. Again, we should keep an eye out for bargains at flea markets. WW II URM signal generators are excellent, as are

¹Notes appear on page 14.

*Senior ARRL Technical Editor

General Radio Model-80 signal generators. (Numerous inexpensive items of homemade test equipment are described in the League book, *Solid State Design for the Radio Amateur*, chapter 7.)

A homemade or commercial rf power meter and a 50-ohm dummy load should be a part of our repair-shop bill of goods. A solder-sucker tool and a low-wattage pencil type of soldering iron are also standard items. A high-intensity desk lamp and magnifying glass will always be useful, too.

Diode Testing

We can determine the general condition of germanium and silicon diodes by means of an ohmmeter. One end of the suspected diode must be unsoldered from the circuit board to isolate it from other components. If this is not done, transistors or resistors that are attached to the immediate circuit of the diode can cause false resistance readings.

Diodes can be tested for forward and back resistance as shown in Fig. 1. Silicon diodes will show a forward resistance between 200 and 300 ohms ($R \times 100$ scale) and a back resistance of 100 to 1000 megohms, typically ($R \times 1$ -megohm scale). Germanium diodes will show a forward resistance of roughly 200 to 400 ohms, with a back resistance of 100 k to 1 megohm. These two readings are obtained with either type of diode by simply reversing the leads of the VOM and changing the VOM multiplier scale. This procedure is useful when selecting matched diodes from a group of diodes. They should be matched as closely as possible for the forward-resistance characteristic.

If no resistance reading is obtained, the diode junction is open. Conversely, if a low-resistance reading is obtained in both directions, the diode is shorted.

Zener Diodes

Zener diodes can be tested for forward and back resistance in the same manner as the diodes we just discussed. But, we are concerned also with the regulation characteristics of our Zener diodes. This parameter can be checked by using the setup shown in Fig. 2. A low current, variable voltage dc power supply is required. The Zener diode under test (D1) is connected across the test leads of a dc voltmeter, as shown. A 1-W, 180-ohm limiting resistor (R1) will suffice for diodes with ratings up to 18 volts. Assume we are checking a 9.1-V Zener diode in Fig. 2. We will set the dc voltmeter to the 15-volt scale. Next, we will vary the power-supply voltage from zero to a point where the voltage across D1 does not increase. This will be the regulation zone of D1. The reading should not increase significantly when the power-supply voltage is raised further. If we are unable to observe a voltage-stabilization point at or near the specified regulation

characteristic of the diode, the component can be considered defective. Always be certain to connect the positive lead from the power supply (via R1) to the *cathode* of the Zener diode, as shown in Fig. 2. This will be the banded end of the diode. This technique is useful for learning the "zener" value of unmarked Zener diodes, such as those obtained as surplus.

Bipolar Transistors

Most failures involving bipolar transistors are caused by faulty associated components, voltage surges or transients that subject the transistors to unsafe voltage or current. In a proper environment the transistor should be capable of outlasting its owner. Therefore, if we locate a defective transistor we should search for the "culprit" that caused the untimely demise. It would be highly speculative simply to pop a replacement transistor into the circuit board!

Although there are a number of simple (and not so simple) transistor testers available, some basic home-workshop checks can reveal the most common faults in these devices. Specifically, we can test them for opens, shorts and high leakage. It is possible to check the transistors for approximate current gain as well.

Junction Testing

Let's think of the bipolar transistor as two diodes (p-n junctions), as in Fig. 3. Malfunction generally results from one of the diodes being damaged (open or shorted). Incorrect operation may result also from excessive leakage (reverse current). If a junction is open, chances are that the failure was caused by excessive current. A shorted junction is most often caused by perforation brought on by voltage spikes that rise beyond the safe rating of the transistor. These conditions serve as clues to the cause of the failure.

Observation of the junction condition can be made if we use an ohmmeter, as shown in Fig. 3. We can check the forward resistance of the junctions in the manner indicated. The ohmmeter polarity

is set for testing an npn type of transistor. The positive and negative meter leads must be reversed when checking a pnp device. The method is otherwise the same as that shown in Fig. 3. A normal resistance reading should be 300 to 600 ohms, depending on the transistor under test (TUT). High resistance readings indicate an open junction.

We can test the junctions for shorts by reversing the ohmmeter leads and switching the meter to a higher resistance scale. This is shown in Fig. 4. This reverse-resistance reading is taken with the ohmmeter switched to the $R \times 10$ k scale. The meter places a reverse bias on the junctions in this hookup. Low- to medium-power transistors (npn) should indicate a reading of 800 k Ω to as much as several megohms. A typical range for germanium

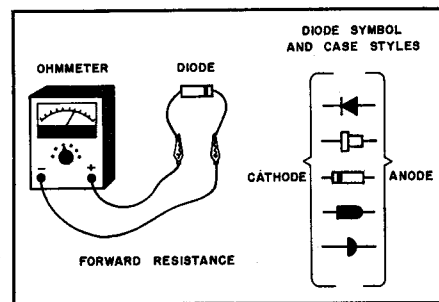

Fig. 1 — Method for checking the condition of small-signal and rectifier diodes with an ohmmeter.

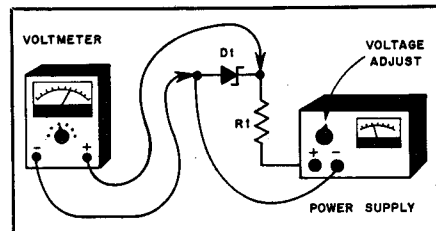

Fig. 2 — Zener diodes can be tested by using a variable dc power supply and a voltmeter.

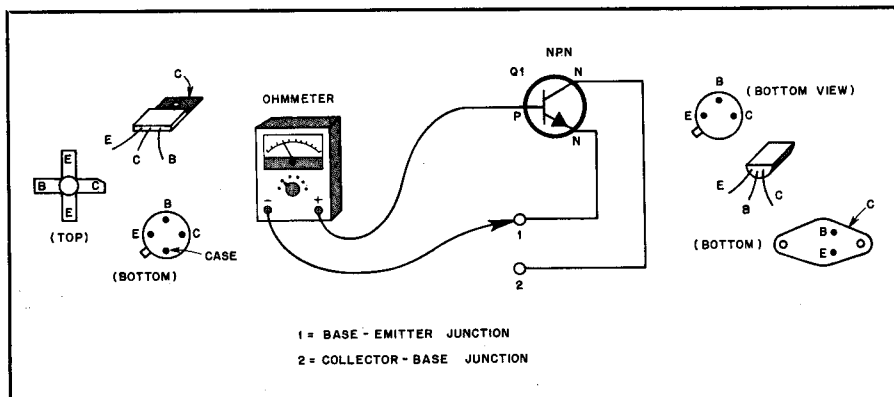

Fig. 3 — Technique for checking the forward resistance of a bipolar transistor. Shorts and opens can be detected in this manner.

transistors is 500 kΩ to 1.5 megohm. High-power transistors have much larger junctions. Therefore, the reverse readings will be lower than for small-signal transistors. Typical readings will be on the order of 50 kΩ or greater. This test indicates the leakage (large) trait of the transistor. We need only reverse the meter leads from the polarity shown in Fig. 4 when testing pnp transistors. It is important that we note the following: The resistance readings we obtain are relative at best, since an ohmmeter can respond accurately only to linear resistances. The readings we obtain will differ with various brands of instruments. Similarly, they will be different if we use meter scales other than $R \times 100$ and $R \times 10$ k. If there is doubt concerning the reliability of our measurements, we can obtain a set of typical readings first by testing an equivalent transistor of known quality (new) and by using the readings as a standard when testing suspected transistors.

Direct-Current Measurements

A more precise method of measuring leakage can be accomplished by using a dc-voltage source and a 100-μA dc meter (see Fig. 5). Most low- and medium-power pnp (germanium) transistors will exhibit collector-base (I_{cbo}) and emitter-base (I_{ebo}) leakage currents on the order of 15 μA maximum at approximately 25° C. High-power transistors will have leakage amounts of 90 μA or greater. Silicon npn transistors have much lower leakage — usually less than a microampere. Excessive leakage in any transistor indicates that excessive heat or overloading has taken place. Since ambient temperature (which affects the junction temperature) has a marked effect on the leakage readings we should double the expected leakage current for each 10° C increase in temperature. Pnp transistors can be checked by reversing the battery and meter polarity from that of Fig. 5.

Testing for Current Gain (Beta)

The dc beta is the ratio of the collector current to the base current. Hence, if a base current of 1 mA were flowing, and the resultant collector current became 70 mA, the beta would be 70. A check of the manufacturer's specifications would indicate whether or not the transistor was exhibiting a beta within the published boundaries. A typical beta spread might be, say, 30 to 100 for a given transistor, owing to nonuniformity of performance characteristics for a specified transistor type from a particular manufacturing batch. In other words, if we picked up 10 type 2N2222A transistors, it would be unlikely that any two would have identical beta traits.

Ac beta is a parameter of interest to us in signal-amplification circuits. This is a bit more difficult to measure accurately with simple methods. But, we can make

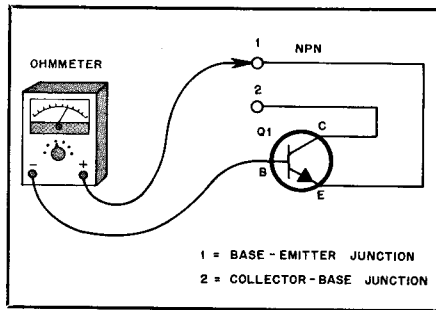

Fig. 4 — Reverse junction resistance of a bipolar transistor can be tested in this fashion.

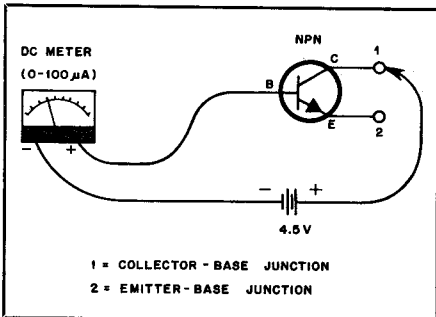

Fig. 5 — Transistor leakage can be investigated with a voltage source and a microammeter, as shown.

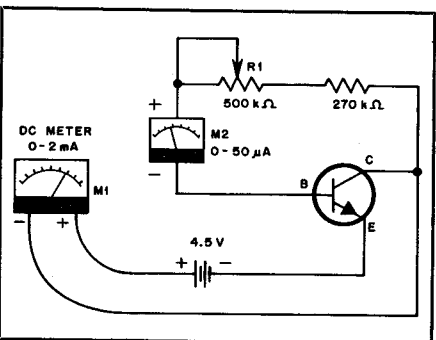

Fig. 6 — Test set-up for determining the dc beta of a transistor.

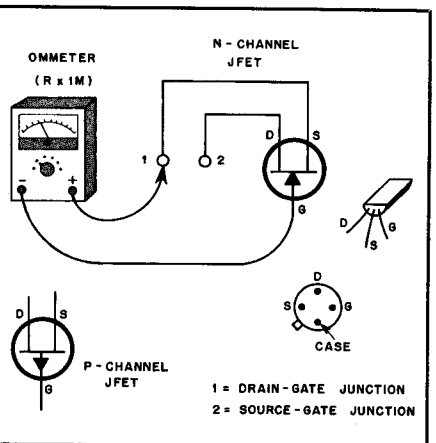

Fig. 7 — System for checking the forward and reverse resistance of a junction FET.

the reasonable assumption that if the dc beta is within the specified range, the ac beta will be all right too.

A simple technique for measuring the dc beta of a transistor is illustrated in Fig. 6. R1 is set for a base current of 10 μA. Then the collector current is noted on M1. From this we can determine the dc beta from I_c/I_b with both currents expressed in μA. Therefore, if we had 10 μA of base current and 0.75 mA of collector current, the beta would be $750/10 = 75$. By reversing the meter and battery polarities in Fig. 6 we can check the dc beta of pnp transistors.

Junction Field-Effect Transistors (FETs)

N-channel JFETs can be checked for opens or shorts if we use the method shown in Fig. 7. With the ohmmeter negative lead hooked to the gate, check positions 1 and 2 with the positive meter lead. If the FET is good, the resistance reading ($R \times 1$ megohm scale) will be several megohms, possibly as high as 1000. If we connect the positive meter lead to the gate and check from source to gate, and drain to gate, we should obtain a resistance reading ($R \times 100$ scale) of 500 to 1000 ohms, typically. P-channel JFETs can be tested by reversing the polarity of the meter leads and performing the same tests. Low-resistance readings indicate high leakage or shorts. Infinite readings in reverse resistance indicate an open junction.

Dual-Gate MOSFETs

It becomes a bit more difficult to test metal-oxide-silicon FETs (MOSFETs), since the gates are insulated from the drain and source of the transistor by a thin, fragile layer of oxide insulating material. If the gates are not protected internally (Zener diodes from the gates to the source) even the static charge on our fingers can destroy the gate insulation. MOSFETs with Zener-protected gates can be damaged easily by voltage peaks greater than about 6 volts, so it is best to handle them with more care than we might give to JFETs or bipolar transistors.

Owing to the gates being insulated from the drain and source, we cannot make forward and reverse measurements with an ohmmeter. An alternative test method is to plug them into a simple crystal oscillator of the type presented in Fig. 8. Rf energy from the oscillator drain is rectified by a diode doubler (D1 and D2), and the resultant dc is monitored at M1. If the MOSFET is defective there will be no meter deflection. A transistor socket can be placed on the test fixture to permit easy connection of the device to be checked.

Warning: Make sure that S1 is in the OFF mode before plugging Q1 into the tester; likewise when removing Q1.

Y1 can be any fundamental crystal in the hf range, but the circuit constants in

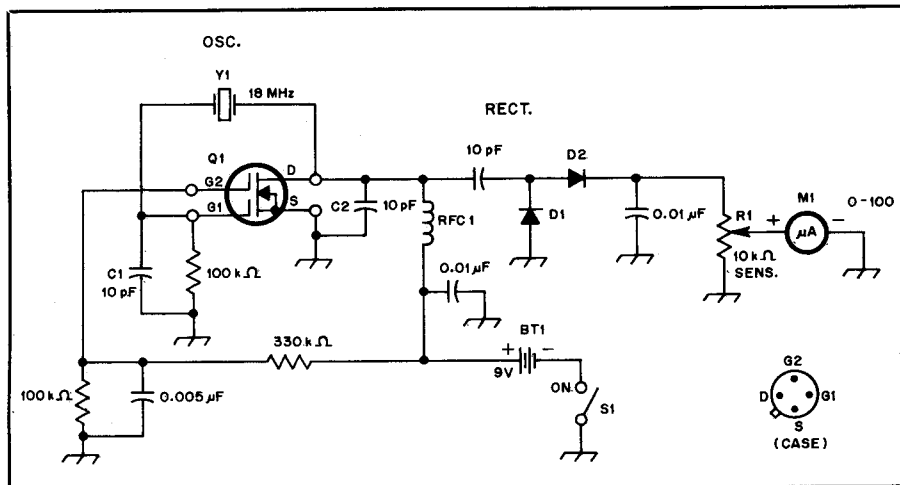

Fig. 8 — Practical circuit for testing a MOSFET (see text). All capacitors are disc ceramic, 10 V or greater. BT1 can be a 9-V transistor-radio battery. D1 and D2 are small-signal germanium diodes (1N34A or equiv.). M1 may be a 50- or 100- μ A dc meter (see text). R1 is a linear-taper composition control, and RFC1 can be a miniature rf choke (500 μ H to 2.5 mH suitable). S \dagger — Spst slide or toggle switch, any frequency (see text). Y1 — High-frequency, fundamental-cut crystal,

Fig. 8 are for use from 15 to 21 MHz. If crystals for lower frequencies are used it may be necessary to increase the value of feedback capacitors C1 or C2, or both. A similar tester that accommodates bipolar transistors, JFETs and MOSFETs, inclusive of a polarity-reversing switch, appears in the measurements chapter of the *Handbook* (past several editions). A simple go-no-go type of MOSFET tester is shown in an RCA publication.² **Caution:** Before performing any of the tests that require the use of a VOM, make certain that a positive potential does, in fact, exist at the positive output jack! Some VOMs and

VTVMs exhibit a negative potential at the positive jack, and a positive potential at the negative or ground jack. The condition of your instrument can be checked by attaching a second voltmeter in parallel with the output leads of the first meter. A forward needle deflection on the second voltmeter will indicate which jack of the first instrument is positive. Use that lead as the positive one for all of the tests that require a VOM.

What About ICs?

It would be a difficult, if not impossible, undertaking to determine the condi-

tion of an integrated circuit (IC) by simple means. We have such a wide variety of ICs to deal with that it seems almost incomprehensible. Things are complicated further by the myriad pin-out arrangements and case styles. We wouldn't even find it convenient to build a functional tester of the type in Fig. 8, because each type of IC would require a special functional-test circuit. The most practical option before us is to localize the malfunction and make a strong assumption that the IC in that part of the circuit has caused the equipment failure. Removing the suspected IC and substituting a new one will provide the answer. Voltage checks (ac and dc, as applicable) at the pins of the ICs may offer clues concerning the IC performance, but generally will not yield conclusive results.

Summary Remarks

This installment on servicing can best be thought of as "openers" for the game of home-workshop repair. Subsequent treatment of amateur servicing techniques will deal with voltage measurements (typical voltages at the semiconductor terminals), isolating the problem area, signal tracing and waveform analysis. Meanwhile, you should be able to apply the principles discussed in Part 1 to locate minor faults and make easy repairs.

Notes

- ¹An inexpensive homemade FET VOM is described (pc board pattern included) in recent editions of *The ARRL Radio Amateur's Handbook*, measurements chapter. The next installment of *Beginner's Bench* will describe the construction of a high-impedance voltmeter and an rf probe.
- ²*RCA Solid-State Servicing* (TSG-1673A), ch. 7, p. 260.

SEASON'S GREETINGS FROM THE HAMS AT ARRL/IARU HQ. (Listed in alphabetical order of call sign)

Joel Kleinman	N1BKE
Richard Palm	K1CE
Jeannie DeMaw	W1CKK
Laird Campbell	W1CUT
George Grammer	W1DF
Elizabeth H. Karpie	KA1DTU
Joan Merritt	KA1DTV
Byron Goodman	W1DX
Maureen Thompson	KA1DYZ
Stephen C. Place	WB1EYI
Paul K. Pagel	N1FB
Doug DeMaw	W1FB
Hal Steinman	K1FHN
Marian Anderson	WB1FSB
Marge Tenney	WB1FSN
John Nelson	W1GNC
Bill Webb	WB1GOW
Bob Atkins	KA1GT

Ed Tilton
Jim Clary
Jean Peacor
Stuart B. Leland
Brian Downey
Dennis Lulis
Stan Horzepa
Peter O'Dell
Sally H. O'Dell
Mike Kaczynski
Bruce Kampe
George Woodward
Ed Kalin
Richard L. Baldwin
Lee Aurick
Gerald L. Hall
Perry F. Williams
George Collins
Arlene Bender
Bill Jennings
Chuck Bender
Bob Halprin

W1HDQ
WB9IHH
K1IJV
W1JEC
WA1KSF
W1LJ
WA1LOU
KB1N
KB1O
W1OD
WA1POI
W1RN
K1RT
W1RU
W1SE
K1TD
W1UED
KC1V
WA1VMC
K1WJ
W1WPR
K1XA

John Lindholm
Sandy Gerli
Ellen White
David Sumner
Steve Pink
Carol L. Colvin
Mark J. Wilson
Don Search
W. Dale Clift
Larry Wolfgang
William A. Tynan
Gerry Hull
Paul Rinaldo
John Troster
Chuck Chadwick
Chuck Hutchinson
Bernard D. Glassmeyer
Harry MacLean
Maxim Memorial Station
ARRL Hq. Station

W1XX
AC1Y
W1YL/4
K1ZZ
KF1Y
AJ2I
AA2Z
W3AZD
WA3NLO
WA3VIL
W3XO
AK4L/VE1CER
W4RI
W6ISQ
K8AXL/
WB8MOB
K8CH
W9KDR
VE3GRO
W1AW
W1INF