

# A Morse Readout for Your Digital Dial

Modern instrumentation has introduced new problems for the visually handicapped. What to do about dials, frequency counters or multimeters that have digital readouts? For sightless radio amateurs, W3ICB offers this practical solution.

By William H. Alliston,\* W3ICB

After I heard of a few near misses in traffic when a mobile operator glanced down to see his transceiver frequency setting, the thought arose that an audible frequency readout would be a definite safety feature. Talking to blind amateur operators in the area reinforced the opinion that such a device is needed. Modern digital instrument displays create new problems for the blind amateur experimenter who can no longer check dial settings by touch with the cover glass removed. An attempt to come up with an audible readout to fill this need resulted in the device described here — a nine- or 10-IC CMOS circuit that can read out typical multiplexed 7-segment digital displays in Morse numerals. The circuit fits on a printed-circuit board about three inches (76 mm) on a side — a size that can be fitted inside many transceiver cases, or used as a small external add-on with others. It can be used with digital dials, frequency counters, digital multimeters or most equipment having multiplexed 7-segment LED digital readouts.

The problem of decoding the 7-segment outputs into something usable to drive a Morse generator was solved by a search through the integrated-circuit literature. The search turned up a lucky find — a 7-segment to BCD decoder. The CMOS version — the 74C915 — was selected, and our local supplier had them in stock. (On rare occasions, the converse of Murphy's Law applies!)

The choice of Morse code for the audible readout was arbitrary.<sup>1</sup> While a slight-

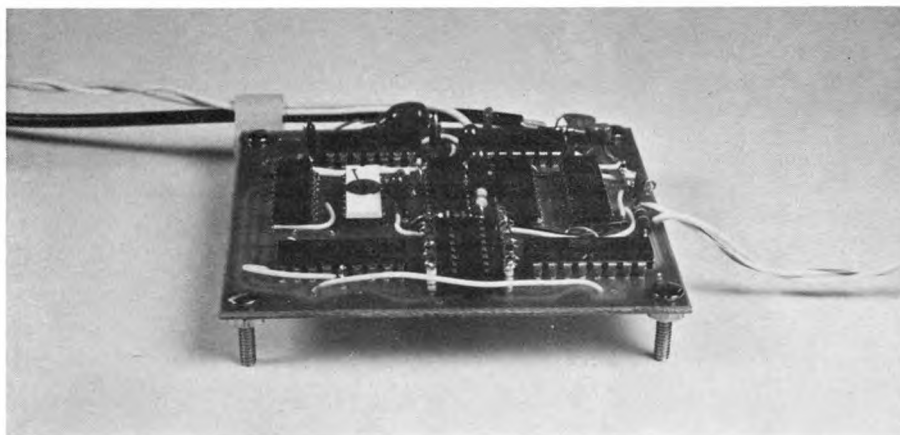

The circuit-board arrangement for W3ICB's Morse Readout designed for use with digital dials.

ly simpler circuit can be devised with a "count the beeps" output, Morse is a logical choice for radio amateurs.

## Circuit Operation

The functioning of the circuit can be followed in Fig. 1. The 7-segment digit voltages from the multiplexed display come up sequentially on the input lines, *a* through *g*, while one of the strobe lines (1 through 7 — one for each digit) will be *on* to supply voltage to the digit being displayed during its time slot. This happens rapidly — perhaps 30 to several hundred times per second in typical displays. These digits are "caught on the fly" in the 74C915 decoder (U1) and are stored there by a set of digital latches during the audible readout. A counter, U3, and an 8-channel multiplexer, U2, are used to

select each digit, one at a time, when its strobe line is on.

When the START button is depressed, U3 is preloaded with a value equal to the number of digits to be read out. The counter output (in BCD) goes to multiplexer U2 as an address. When the corresponding display-digit strobe line turns on, the resulting output from the multiplexer momentarily operates the latches in U1 so that the digit is stored for readout.

When one digit has been sent in Morse code, a reset signal results that causes U3 to count down by one, selecting the next digit for readout. (The reset is generated by one-half of the 74C221 dual monostable, U6, and is also the right length to form the pause between Morse digits.) When U3 changes count, the multiplexer,

\*4880 Greensburg Rd., Murrysville, PA 15668

<sup>1</sup>Notes appear on page 37.

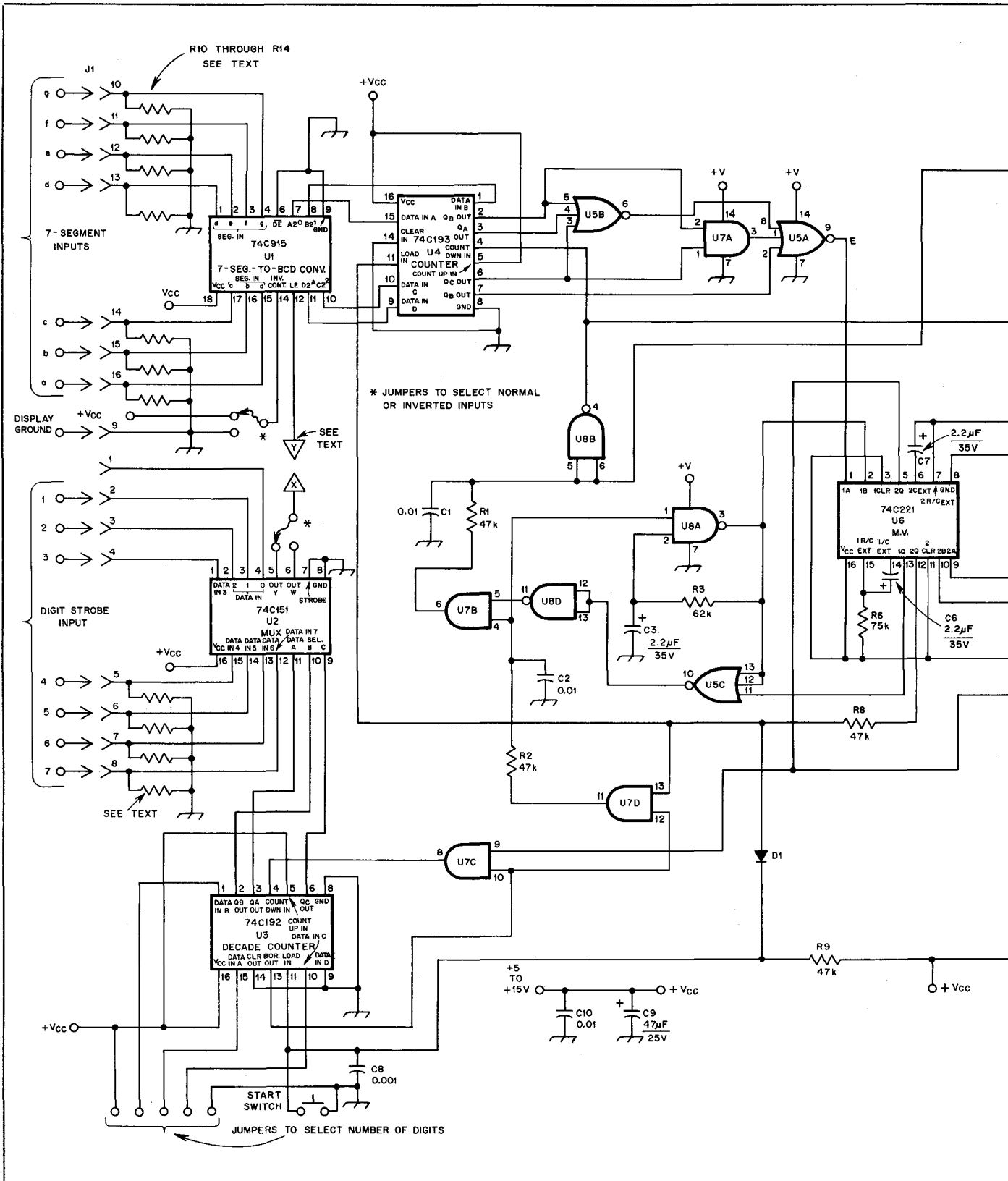

Fig. 1 — Circuit diagram for the Digital Display Morse Readout. Values indicated for R24 and R25 below are typical, but a change may be needed with a change in strobe frequency.

- C1, C2, C10, C11 — 0.01- $\mu$ F ceramic, 50 V.
- C3, C6, C7 — 2.2- $\mu$ F tantalum electrolytic, 35 V.
- C4 — 0.015- $\mu$ F ceramic, 50 V.
- C5 — 0.1- $\mu$ F ceramic, 50 V.
- C8 — 0.001- $\mu$ F ceramic, 50 V.
- C9 — 47- $\mu$ F tantalum electrolytic, 25 V.
- C12 — 250-pF ceramic, 50 V.
- D1 — 1N4148 silicon switching diode.
- J1 — 16-pin DIP socket.

- R1, R2, R5, R8, R9 — 47 k $\Omega$ , 1/8 or 1/4 W.
- R3 — 62 k $\Omega$ , 1/8 or 1/4 W.
- R4 — 100 k $\Omega$ , 1/8 or 1/4 W.
- R6 — 75 k $\Omega$ , 1/8 or 1/4 W.
- R7 — 180 k $\Omega$ , 1/8 or 1/4 W.
- R10-R24, incl. — See text.
- R25 — 270 k $\Omega$ , 1/8 or 1/4 W.
- R26 — 330 k $\Omega$ , 1/8 or 1/4 W.

- U1 — MM74C915, 7-segment to BCD converter.
- U2 — MM74C151, 8-bit data selector/multiplexer.
- U3 — MM74C192, synchronous up/down decade counter.
- U4 — MM74C193, synchronous up/down 4-bit binary counter.

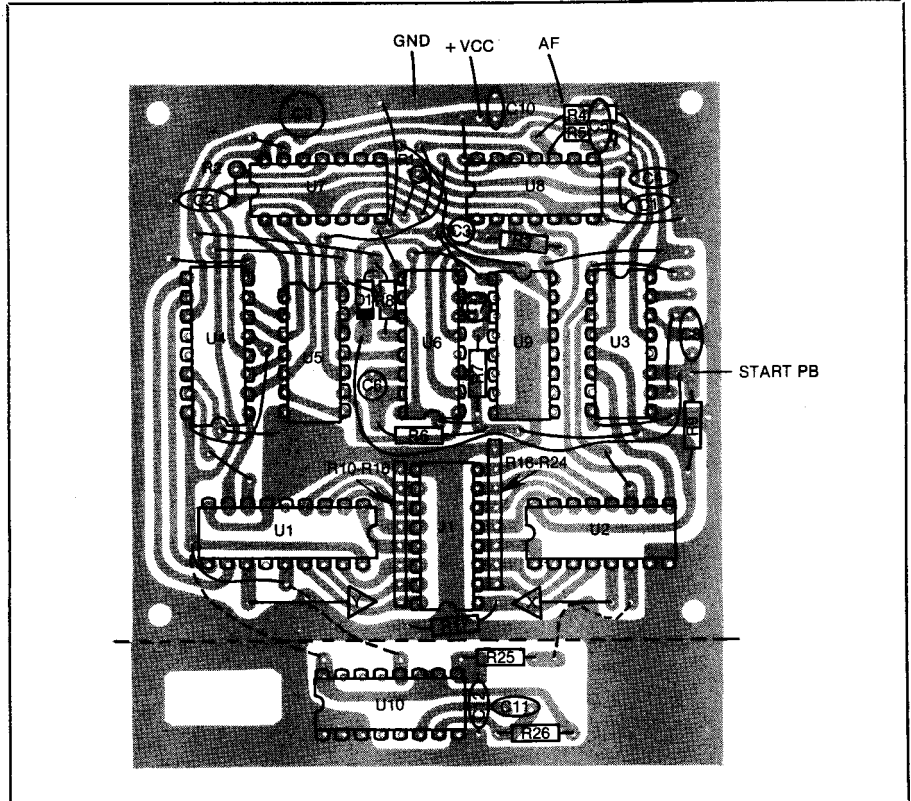
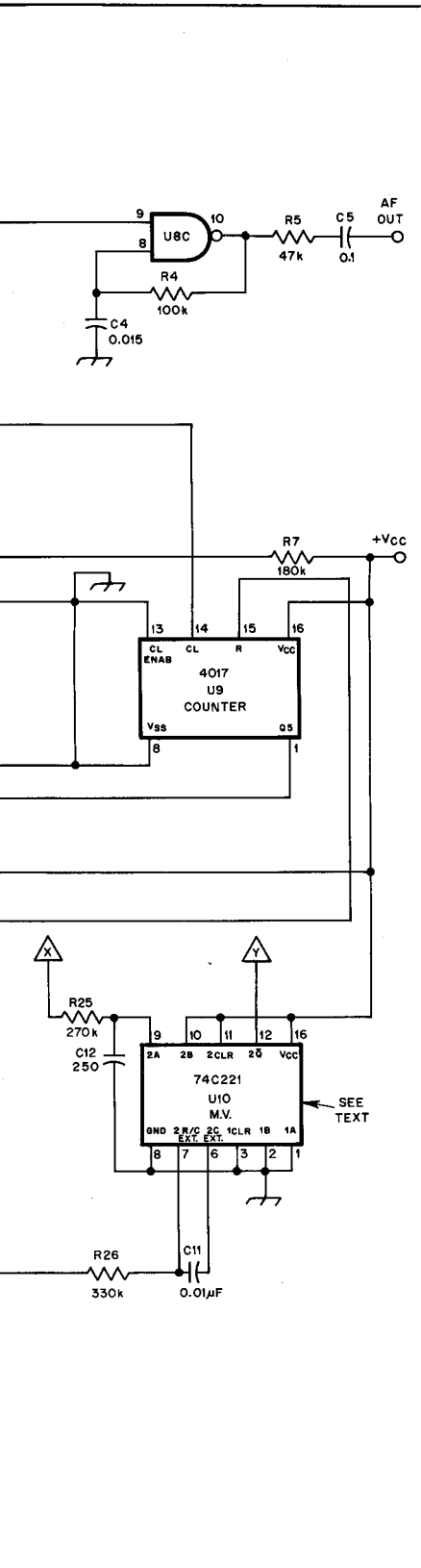

Fig. 2 — Parts layout and wire jumpers for the Digital Display Morse Readout, shown from the component side of the board. The shaded area represents an X-ray view of the copper pattern. The etching pattern appears in the "Hints and Kinks" section of this issue.

U2, is shifted to select the next digit for readout and the process repeats. This continues until all digits have been sent in Morse code. When the last digit has been sent (with U3 on logic 1), the end of the next reset pulse will cause the "borrow" output of U3 to change. The borrow output is then used as a stop signal to halt the Morse readout until the START push button is again depressed.<sup>2</sup>

### Morse Numeral Generator

Several methods are available for generating Morse digits. Among them are storing the dits and dahs in an ROM or a preloaded shift register, and coding them with diode arrays and counters. The method used here involves a binary counter, U4, and three gates, U5A, U5B and U7A. These are set up to generate the truth table shown in Table 1. Any time the output E of this combination is *low*, a dah will be sent and any time it is *high*, a dit will be produced. The number from the U1 decoder, now coded in BCD, is used to preset the U4 counter. A dit oscillator, U8A, causes this counter to count downward. If voltage E is high (Fig. 1) each pulse is sent as a dit. Whenever E is low, the other half of monostable U6 is used to stretch the output to form a dah. It can be seen from Table 1, for example, that if a "5" is set on the U4 counter, five dits will be sent as it is counted down. If a

"7" is set, two dahs will be sent (one at "7," another at "6"), and the rest will be dits. For a "2," two dits will be sent (one at "2," another at "1"). On reaching "0" a dah will be sent. At the next count down, the counter will recycle back to "15" and continue sending dahs. In this way all of the Morse numerals can be formed. Since all Morse numerals consist of five total dits and dahs, another counter, U9, a CMOS decimal counter, is used to trigger the reset to stop the dit-dah transmission after five total dits or dahs

Table 1  
Truth Table for the Morse Digit Generator

Decimal Digit	Binary	E
0	0000	0
1	0001	1
2	0010	1
3	0011	1
4	0100	1
5	0101	1
6	0110	0
7	0111	0
8	1000	0
9	1001	0
10	1010	0
11	1011	0
12	1100	0
13	1101	0
14	1110	0
15	1111	0

- U5 — CD4025, SK4025 etc. triple 3-input NOR gate.
- U6, U10 — MM74C221, dual monostable multivibrator.
- U7 — MM74C08, quad 2-input pos. AND gate with Schmitt-Trigger inp.
- U8 — CD4093, quad 2-input NAND Schmitt Trigs.
- U9 — CD4017 CMOS decade counter/divider.

have been sent for each digit displayed. Fig 2 is a parts layout of the circuit.

### Leading Zeros and the Decimal Point

Note that when a blank occurs (all digit segments, *a* through *g*, turned off) U1 generates a "15." Since a "15" setting will cause the Morse generator to send a zero, blanked-out "leading zeros" in the display will also be sent as Morse zeros. (If your display blanks leading zeros instead by turning off the strobe, this may not work; circuit additions not covered here would have to be made to handle the leading zeros.<sup>3</sup>)

No provision has been made to handle the decimal point, since it was assumed that a user would know the correct decimal position in his display. A circuit to detect the decimal position and send R or other appropriate symbol should be a straightforward addition; reader suggestions are invited.

### Interconnection with the Display

Connections from the display are brought into the Morse readout circuit board via a 16-pin DIP header connector. Flat tape cable is convenient for making the hookup. There are seven leads for the display segment voltages, *a* through *g*, and up to seven strobe lines, one for each digit, plus a common ground, on the DIP connector. These are connected to the corresponding points on the digital display. Be sure to make the connections above the display dropping resistors. It's a good idea to connect each lead (except the ground) through a resistor (say a few thousand ohms) at the digital display. Thus, in case of a short, no damage will be done to the display drivers. As noted later, these resistors can be a part of the voltage divider used to get the correct input voltage to U1 and U2.

While cable length ordinarily would not be critical, there might be a problem with rf pickup around transmitters, especially if the cable is routed outside the equipment cabinet. In addition, long, unshielded leads from your display could radiate hash into your receiver from the switching of the multiplexed digits. In either case, shielding the cable or bypassing the leads, or both, might be needed. Small bypass capacitors can be connected across the pull-down resistors near the DIP header socket if required. The impedance of the bypass capacitors should be large at the display strobe frequency. With typical strobe frequencies, however, this requirement is easily met and bypass capacitors of a few hundred pF can be used.

Your digital display may use either common cathode or common anode LED displays. The 74C915 decoder U1, can operate with either type. With the common-cathode type, the segment voltages will be high (close to the supply voltage) when the segment is on and low (near zero) when it is off. The strobe

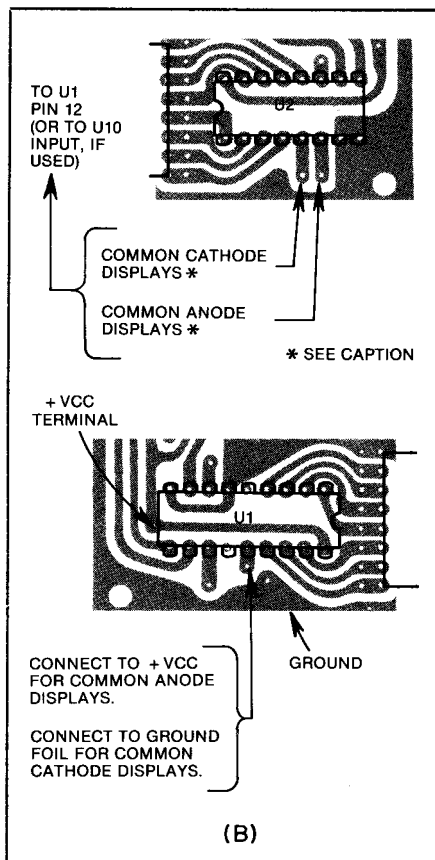

Fig. 3 — The method of selecting strobe polarity is shown in A. Reverse the common-cathode and common-anode display connections if inverting transistors are used on the strobe lines (with display strobe connections made above the transistor base resistors). B illustrates the selection of digit voltage polarity.

voltage on the LED display cathodes will then be low when the digit is on and high when it is off. For common-anode displays, the opposite is true — segment voltages are low when the segment is on; strobe voltage is high for the digit to be on. Arrange the jumpers on U1 and U2 as shown in Fig. 3.

In most displays, buffer transistors are used on the strobe lines. It is generally better to make the Morse readout strobe connections on the base side of these transistors, but above any resistors which might be in series with the base. If these transistors invert the strobe signal, remember to use the opposite set of connections for the strobe polarity shown in Fig. 3.

The CMOS decoder, U1, and the multiplexer, U2, operate best when the high input voltage is within about 90 to 100 percent of the CMOS supply voltage. Depending on the particular display, these voltages could vary widely. If the manual for your display does not give the operating voltage levels, you can measure the peak values using a calibrated oscilloscope. Fortunately, the CMOS ICs

in the Morse readout can operate over a wide voltage supply range — about 5 to 15 volts. Just select a supply voltage that is equal to or a little less than the maximum voltage coming out of the display. A Zener diode or one of the small IC regulators can be used to set the supply voltage for the Morse-readout circuit. The next step is to select the value of input resistors for the Morse readout to get the input voltage between 90 and 100 percent of the supply. For example, Fig. 4 shows how this might be done for a case in which the peak voltage out of the display was found to be 11 volts and the Morse readout is operating on 9 volts.

Using the Morse readout with certain digital displays resulted in occasional readout errors. The problem was traced to the fact that these displays simultaneously turned off the digit segments and the strobe voltage. Since the strobe voltage is used to operate the latches in U1, the digit segments were changing just as they were being stored by the latches.

A quick check with a triggered-sweep oscilloscope will let you know if your display will cause this problem — just compare the traces for the segments and strobe, with the scope synchronized to one of them. If they turn off at the same instant, you have the problem. A simple circuit addition also shown in Fig. 1 can be used to eliminate the problem — it inserts a one-shot multivibrator, U10, in the strobe line (between points X and Y on Fig. 1) to shorten the strobe pulse.<sup>4</sup> The values used for R26 and C11 worked well with a 130-Hz strobe frequency. The values can be adjusted for other strobe frequencies, if required — just change R26 or C11 until a reliable readout is obtained. At the one-shot multivibrator input, R25 and C12 are used to eliminate any short false-strobe pulses which might otherwise trigger the multivibrator. A supplement to the added circuit is shown in the etching pattern in the "Hints and Kinks" section. If your display doesn't need it, the board can be cut along the line "C" shown in the figure.

### Use with Other Types of Displays

Nonmultiplexed (continuously "on") displays are not usable with the Morse readout unless separate ICs are used to multiplex the digits going to it. Because of the large number of connections involved (for example, 43 wires for a 6-digit display), it may not be too practical. In case BCD outputs are available in addition to the 7-segment outputs, U1 and U2 can be eliminated in favor of multiplexers on BCD outputs (now, only 25 wires for a 6-digit display). If you have room to build in the multiplexing on the display, you can get by with only nine leads (four BCD leads, four multiplex address leads and a ground). Multiplexing can be done easily with some of the new Tri-State buffers driven by a BCD-to-decimal decoder. The

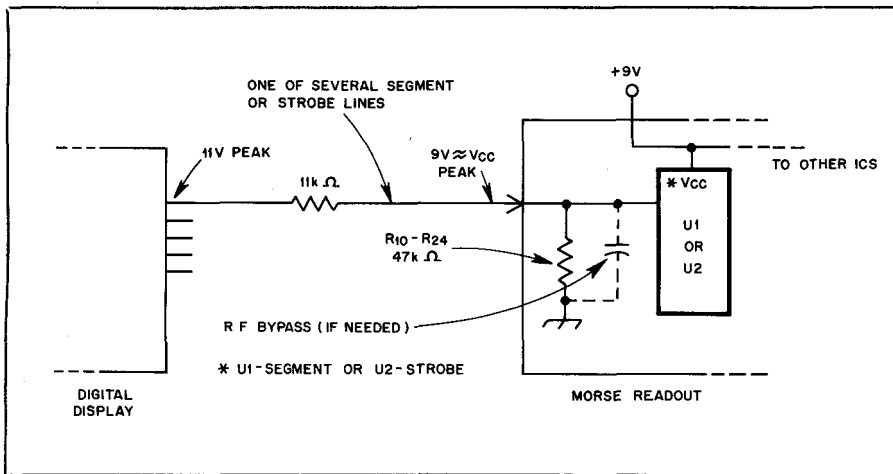

Fig. 4 — An example of a voltage divider for setting the Morse Readout input voltage.

author has not attempted any of these approaches but would appreciate hearing from any amateurs who try it.

### Construction and Checkout

Construction is straightforward using the circuit board and parts layout of Fig. 2. The compact circuit board will be much easier to assemble if a soldering iron with a small tip is used. Since the CMOS integrated circuits can be damaged by static electricity and other stray voltages during assembly, the usual precautions should be taken. The soldering iron and perhaps other tools should be grounded as well as the ground foil and supply lead on the circuit board. Keep in mind that the jumpers on the board for selecting signal polarity and number of digits require the same precautions any time the jumpers are changed. Of course, all connections should be made with power *off*, including connection to the display.

All resistors used in the circuit can be 1/4- or 1/8-watt sizes; it will be difficult to find room for any larger ones. For small size, good stability and low leakage current, dipped-tantalum capacitors have been used for the electrolytic capacitors, with 50-volt ceramic capacitors at other locations in the circuit. (Note that for the signal-conditioning RC circuits, R1-C1 and R2-C2, only single holes had been drilled in the board; hence the connection between R and C must be made on top of the board.)

The inputs to U1 and U2 from the display are connected to ground through pull-down resistors, R10 through R24. These resistors may be omitted for permanently wired installations but are recommended for static-electricity protection in case the input plug is removed. Since LED displays have low impedance, loading the display driver is not a problem and values between 10 kΩ and 1 MΩ are usable. (47 kΩ was used in the prototype circuit.) As noted before, the pull-down resistors can serve as one leg of a voltage

divider to set the correct input voltage. The boards are designed to use single in-line package (SIP) resistor networks for these resistors. Two Bourns-type 4308-101 (seven resistors each with a common ground) can be used. Separate 1/8-watt resistors have been used instead on one of the test boards; they work just as well but do not look as neat.

The number of digits to be read out is selected by jumpers near the U3 counter. The three connections brought out use the 4-2-1 BCD coding (the terminals on the board, as shown in Fig. 5, are actually arranged in the order 4-1-2). To select the number of digits, just connect the appropriate terminals having the total value equal to the desired number of digits to the positive terminal near them. Then ground the unused terminals to the ground foil at the edge of the board. For example, to read out five display digits, connect the "4" and "1" terminals to the positive supply and ground the "2" terminal. When changing these jumpers, be sure to observe precautions to protect the CMOS IC from stray voltages which might damage it.

Before operating, first install the jumpers for polarity and number of digits. Then after carefully checking over the board, connect the ground and positive supply lead to a 5- to 15-volt power supply — current drain should be small (say 0.5 mA at 9 volts, if all is well). Using shielded wire, connect the audio output across the audio volume control on your audio amplifier. When power is turned on, a Morse digit readout will occur or can be started by momentarily grounding the START push-button lead. Without the 7-segment input plug connected, all digits will be read out as either 0 or 8, depending on which input polarity was selected. With all power off, make the plug-in connection to your display and then turn the power on. Assuming correct connections, voltage levels and logic polarity, operating the START push button should give you a

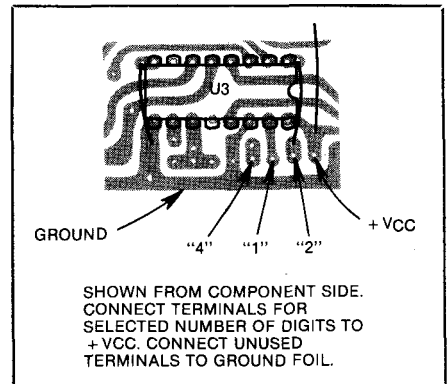

Fig. 5 — Jumpers to select the number of digits for the Morse Readout. When changing these jumpers, be sure to observe precautions to protect the CMOS IC from damaging stray voltages.

Morse readout, left-to-right, of the displayed numerals. (If readout is right-to-left, you have reversed the order of the strobe leads.)

The 47-kΩ series resistor, R5, used in the audio output should give more than adequate audio level in most transceivers. To reduce the level, just add more series resistance at the transceiver end.

RC values used in the dit oscillator (R3-C3) and dah monostable (R6-C6) were selected for operation at about 15 wpm. To change the speed, just change these RC values in the same proportion — lower RC values will give higher speed. Space between Morse digits is set by R7-C7.

Note that to get the proper 3:1 dah-dit ratio, R6-C6 must be selected so that the U6 dah output ends up between two and three dit lengths. Otherwise, short or long dahs will result. While the author has had no problem with this, it might occur as a result of tolerances on the tantalum capacitors or use of a different supply voltage. (The single-Schmitt-Trigger dit oscillator is slightly voltage sensitive.) It can be corrected by trimming the RC value in either the dit oscillator or the dah monostable circuits.

### Notes

- <sup>1</sup>Wry comment to the reader — but it may give some ops their only opportunity for Morse code practice.
- <sup>2</sup>Note that this design can handle seven digits at most since the "borrow" output from the counter is used to stop transmission after position "11." The multiplexer "0" position is thus unused. The circuit can be modified to read out eight digits by using the "8" bit on U3 (pin 7) through an inverter, instead of the "borrow" output, but this will require adding an inverter to the board. The "zero" multiplexer lead has been brought out to J1 to facilitate this change, if desired.
- <sup>3</sup>U1 also provides an error output for improper 7-segment combinations. This feature has not been used here.
- <sup>4</sup>Faulty triggering of U10 has occurred on some boards. A change from the inverted input, pin 9, to the pin 10 input on U10 has cleared up the problem. To make this change, clear the foil around pins 9 and 10 on U10. Then insert wire jumpers from pin 9 to ground and from pin 10 to the pad where R25 and C12 terminate. Also reverse the connection from U2.